

LISTINO PREZZI RICAMBI

SPARE PARTS PRICE LIST

BRUCIATORI SPL 25 - 30 - 35Spec- 50 - 65 -100

BURNERS SPL 25 - 30 - 35Spec- 50 - 65 -100



ISAAM DI ISAIA ALDO F.

Largo Marconi, 3 - 12024 Costigliole Saluzzo (CN) - Italy

Tel: +39 0175 230323 Fax: +39 0175 490262

Cell: +39 339 5735948

INDICE-INDEX

BRUCIATORE SPL 25 - 30 - 35S - 50 - 65 - 100 (DISEGNO) -----BURNER SPL 25 - 30 - 35S - 50 - 65 - 100 (DRAW)	Pag. 3
RICAMBI PER BRUCIATORE SPL 25 - 30 - 35S - 50 - 65 - 100 ----- SPARE PARTS FOR BURNERS SPL 25 - 30 - 35S - 50 - 65 - 100	Pag. 4
VENTILATORE PER BRUCIATORE SPL 25 - 30 - 35S - 50 - 65 - 100 (DISEGNO) -----FAN FOR BURNER SPL 25 - 30 - 35S - 50 - 65 - 100 (DRAW)	Pag. 5
RICAMBI VENTILATORE PER BRUCIATORE SPL 25 - 30 - 35S - 50 - 65 - 100 ----- SPARE PARTS FOR FAN SPL 25 - 30 - 35S - 50 - 65 - 100	Pag. 6
QUADRO ELETTRONICO INTEGRATO MODELLI QB 25-30-35S-50-65 PER BRUCIATORE SPL 25-30-35S-50-65 (DISEGNO) prodotto in corso -----INTEGRATED CONTROL PANEL MODELS QB 25-30-35S-50-65 for BURNER SPL 25-30-35S-50-65 PRODUCT DRAW in construction	Pag. 7
RICAMBI QUADRO ELETTRONICO INTEGRATO PER BRUCIATORE SPL 25 - 30 - 35S - 50 - 65 ----- SPARE PARTS FOR INTEGRATED CONTROL PANEL FOR BURNER SPL 25 - 30 - 35S - 50 - 65	Pag. 8
QUADRO ELETTRONICO MODELLO QC SPL25-30-35S-50-65-100 PER BRUCIATORE SPL25-30-35S-50-65-100 (DISEGNO) prodotto in corso ----- CONTROL PANEL QC MODEL SPL25-30-35S-50-65-100 FOR BURNER SPL SPL25-30-35S-50-65-100 Product Draw in construction	Pag. 9
RICAMBI QUADRO ELETTRONICO QC PER BRUCIATORI SPL 25 - 30 - 35S - 50 - 65 - 100 ----- SPARE PARTS FOR I CONTROL PANEL QC FOR BURNERS SPL 25 - 30 - 35S - 50 - 65 - 100	Pag. 10
QADRO ELETTRONICO MOD.E 25-30-35S-50-65-100 PER BRUCIATORI SPL25-30-35S-50-65-100---DISEGNO (produzione fino a Maggio 2009) ----- CONTROL PANEL MOD.E 25-30-35S-50-65-100 FOR BURNERS SPL25-30-35S-50-65-100 ---DRAW (distributed until May 2009)	Pag. 11
RICAMBI QUADRO ELETTRONICO MODELLO QE PER BRUCIATORI SPL 25 - 30 - 35S - 50 - 65 - 100 ----- SPARE PARTS FOR CONTROL PANEL MOD. QE FOR BURNERS SPL 25 - 30 - 35S - 50 - 65 - 100	Pag. 12
COCLEA D'ALIMENTAZIONE PELLETTI MODELLI 76/1740 E 89/1740 (prodotto in corso di produzione da giugno 2009) PER BRUCIATORI SPL 25 - 30 - 35S - 50 - 65 - 100 ----- PELLET FEED SCREW MODELS 76/1740 AND 89/1740 (product distributed starting form June 2009) FOR BURNERS SPL 25 - 30 - 35S - 50 - 65 - 100	Pag. 13
RICAMBI COCLEA MODELLO DA GIUGNO 2009 PER BRUCIATORI SPL 25 - 30 - 35S - 50 - 65 - 100 ----- SPARE PARTS FOR FEED SCREW MODEL STARTING FROM JUNE 2009 FOR BURNERS SPL 25-30-35S-50-65-100	Pag. 14
COCLEA D'ALIMENTAZIONE PELLETTI MODELLI 76/1740 E 89/1740 per BRUCIATORI SPL 25 - 30 - 35S - 50 - 65 - 100 (produzione fino a maggio 2009) ----- PELLET FEED SCREW MODELS 76/1740 AND 89/1740 FOR BURNERS SPL 25 - 30 - 35S - 50 - 65 - 100 (distributed until May 2009)	Pag. 15
RICAMBI COCLEA MODELLO PER BRUCIATORI SPL 25 - 30 - 35S - 50 - 65 - 100 ----- SPARE PARTS FOR FEED SCREW MODEL FOR BURNERS SPL 25 - 30 - 35S - 50 - 65 - 100	Pag. 16

BRUCIATORE-BURNER SPL 25 - 30 - 35S - 50 - 65 - 100

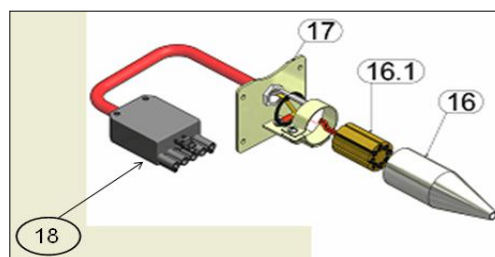
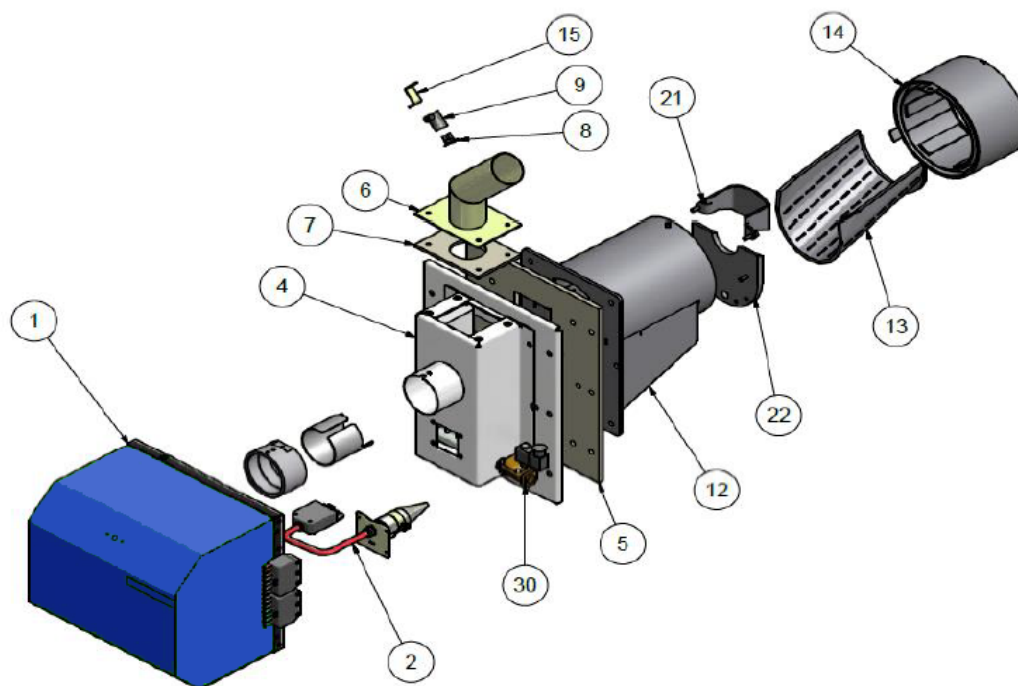







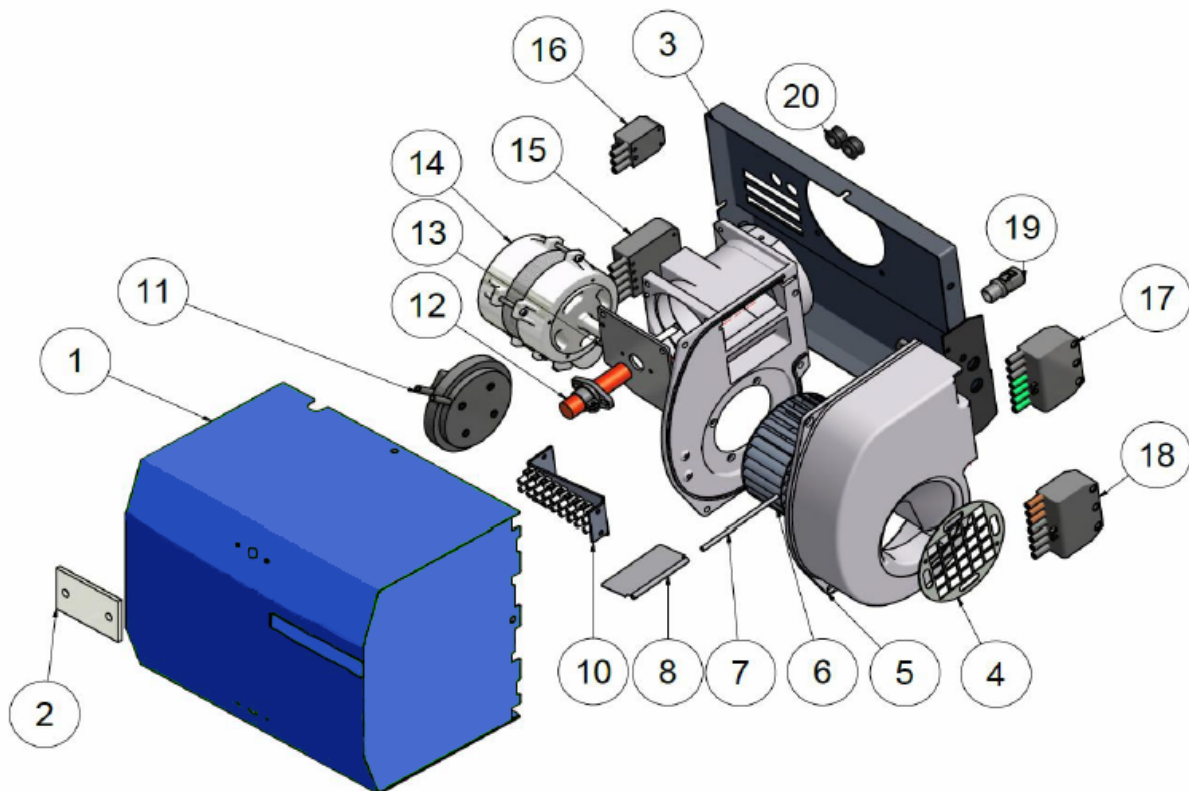





I pezzi di ricambio indicati alla pagina successiva sono quelli consigliati per la dotazione del servizio di manutenzione e riparazione, i prezzi di altri componenti vengono forniti su richiesta
 -----Spare parts in the next page are suggested for maintenance and technical service, the price of other components are supplied on demand.

RICAMBI PER BRUCIATORE---SPARE PARTS FOR BURNER SPL 25 - 30 - 35S - 50 - 65 - 100					
Posizione nel disegno	CODICE	IMMAGINE	DESCRIZIONE - I -	DESCRIPTION - EN -	Prezzo €
2	ACC400WCS		ACCENDITORE 400W COMPLETO DI STAFFA E CABLAGGIO (Per SPL25-30-35S-50-65-100)	400 W IGNITER WITH SUPPORT AND WIRING (For SPL25-30-35S-50-65-100)	292,00
2	ACC400WCS+F		ACCENDITORE 400W COMPLETO DI STAFFA E CABLAGGIO CON PULIZIA (Per SPL25-30-35S-50-65-100)	400 W IGNITER WITH SUPPORT AND WIRING (For SPL25-30-35S-50-65-100)	344,00
5	GSB/SPL25		GUARNIZIONE SUPPORTO SPL25	SUPPORT SEAL SPL25	29,00
	GSB/SPL35		GUARNIZIONE SUPPORTO SPL30	SUPPORT SEAL SPL30	29,00
	GSB/SPL35S		GUARNIZIONE SUPPORTO SPL35S	SUPPORT SEAL SPL35S	34,00
	GSB/SPL50		GUARNIZIONE SUPPORTO SPL50	SUPPORT SEAL SPL50	34,00
	GSB/SPL65		GUARNIZIONE SUPPORTO SPL65	SUPPORT SEAL SPL65	39,00
	GSB/SPL100		GUARNIZIONE SUPPORTO SPL100	SUPPORT SEAL SPL100	39,00
7	GTDC/SPL25		GUARNIZ. TUBO DI CARICO SPL25	SUPPLY PIPE SEAL SPL25	4,50
	GTDC/SPL35		GUARNIZ. TUBO DI CARICO SPL30	SUPPLY PIPE SEAL SPL30	4,50
	GTDC/SPL35S		GUARNIZ. TUBO DI CARICO SPL35S	SUPPLY PIPE SEAL SPL35S	4,50
	GTDC/SPL50		GUARNIZ. TUBO DI CARICO SPL50	SUPPLY PIPE SEAL SPL50	4,50
	GTDC/SPL65		GUARNIZ. TUBO DI CARICO SPL65	SUPPLY PIPE SEAL SPL65	5,50
	GTDC/SPL100		GUARNIZ. TUBO DI CARICO SPL100	SUPPLY PIPE SEAL SPL100	5,50
8	TK		TERMOSTATO KLIKSON	KLIKSON THERMOSTAT	14,00
9	COTK		COPRITERMOSTATO	COVER FO KLIKSON THERMOSTAT	16,00
13	GDG/SPL25		GRIGLIA GASIFICAZIONE SPL25	GASS GRILL SPL25	188,00
	GDG/SPL35		GRIGLIA GASIFICAZIONE SPL30	GASS GRILL SPL30	188,00
	GDG/SPL35S		GRIGLIA GASIFICAZIONE SPL35S	GASS GRILL SPL35S	218,00
	GDG/SPL50		GRIGLIA GASIFICAZIONE SPL50	GASS GRILL SPL50	218,00
	GDG/SPL65		GRIGLIA GASIFICAZIONE SPL65	GASS GRILL SPL65	396,00
	GDG/SPL100		GRIGLIA GASIFICAZIONE SPL100	GASS GRILL SPL100	396,00
14	TBOC/SPL25		TERMINALE BOCCAGLIO SPL25	TERMINAL NOZZLE SPL25	148,00
	TBOC/SPL35		TERMINALE BOCCAGLIO SPL30	TERMINAL NOZZLE SPL30	148,00
	TBOC/SPL35S		TERMINALE BOCCAGLIO SPL35S	TERMINAL NOZZLE SPL35S	196,00
	TBOC/SPL50		TERMINALE BOCCAGLIO SPL50	TERMINAL NOZZLE SPL50	196,00
	TBOCR/SPL65		TERMINALE BOCCAGLIO SPL65	TERMINAL NOZZLE SPL65	488,00
	TBOCR/SPL100		TERMINALE BOCCAGLIO SPL100	TERMINAL NOZZLE SPL100	488,00
16	ST400		UGELLO ACCENDITORE	IGNITER NOZZLE	190,00
16,1	REAC		RESISTENZA PER ACCENDITORE	IGNITER RESISTANCE	115,00
17	STAC		STAFFA CON PRESSACAVO	SUPPORT WITH PRESS CABLE	17,00
18	CO5NFCM		CONNETTORE 5 POLI NERO	BLACK 5 POLAR CONNECTOR	7,00
21	BP025.12C		FERMAPELLET SPL 25	PELLET STOPPER SPL25	32,00
	BP035.12C		FERMAPELLET SPL 30	PELLET STOPPER SPL30	32,00
	BP035S.12C		FERMAPELLET SPL 35 Special	PELLET STOPPER SPL35S	42,00
	BP050.12C		FERMAPELLET SPL 50	PELLET STOPPER SPL50	42,00
	BP065.12C		FERMAPELLET SPL 65	PELLET STOPPER SPL65	56,00
	BP100.12C		FERMAPELLET SPL 100	PELLET STOPPER SPL100	56,00

VENTILATORE PER BRUCIATORE---FAN SPARE PARTS FOR BURNER
SPL 25 - 30 - 35S - 50 - 65 - 100



I pezzi di ricambio indicati alla pagina successiva sono quelli consigliati per la dotazione del servizio di manutenzione e riparazione, i prezzi di altri componenti vengono forniti su richiesta
 -----Spare parts in the next page are suggested for maintenance and technical service, the price of other components are supplied on demand





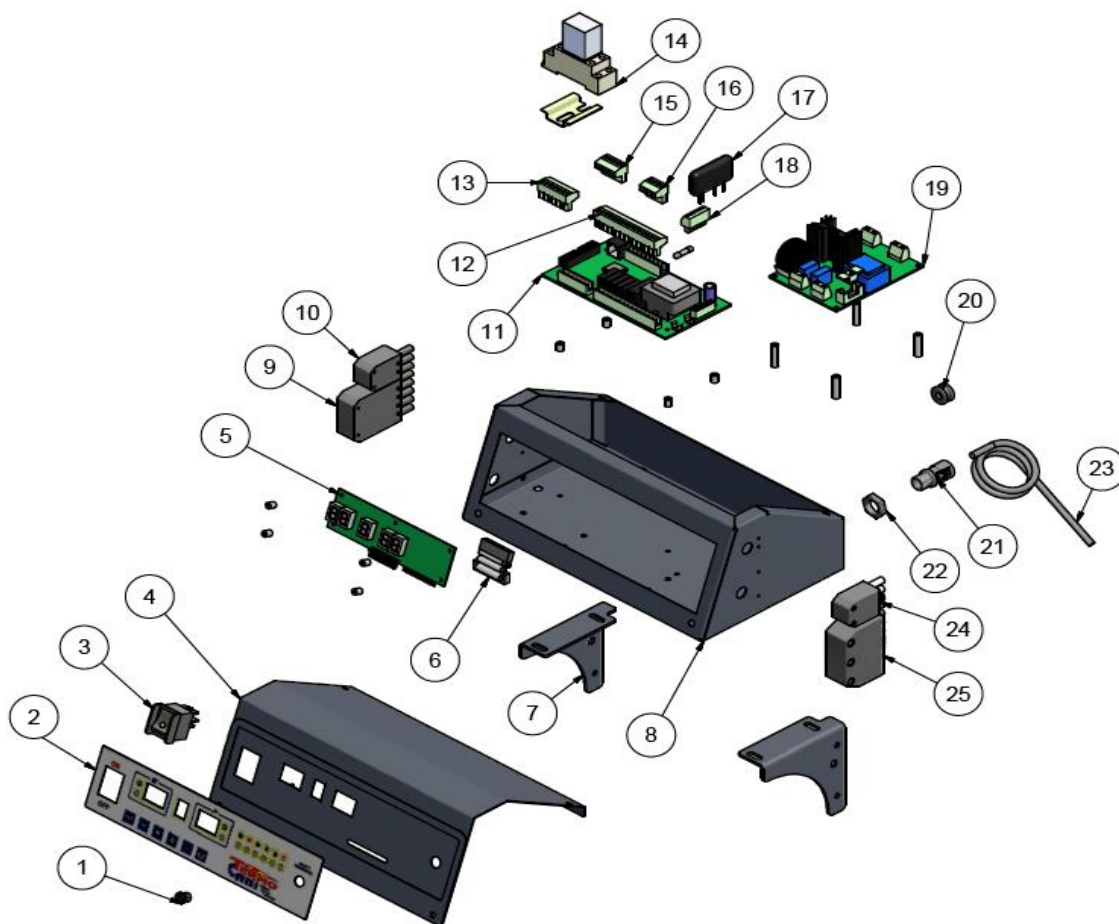



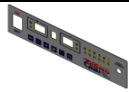

RICAMBI VENTILATORE PER BRUCIATORE--FAN SPARE PARTS FOR BURNER					
SPL 25 - 30 - 35S - 50 - 65 - 100					
Posizione nel disegno	CODICE	IMMAGINE	DESCRIZIONE - I -	DESCRIZIONE - EN -	Prezzo €
6	VEN/SPL25		VENTOLA SPL25	FAN SPL25	25,00
	VEN/SPL35		VENTOLA SPL30	FAN SPL30	25,00
	VEN/SPL35S		VENTOLA SPL35S	FAN SPL35S	33,00
	VEN/SPL50		VENTOLA SPL50	FAN SPL50	33,00
	VEN/SPL65		VENTOLA SPL65	FAN SPL65	49,00
	VEN/SPL100		VENTOLA SPL100	FAN SPL100	49,00
7	AS/SPL25		ASTA SERRANDA VENTILATORE SPL25	SHUTTER ROD SPL25	2,00
	AS/SPL35		ASTA SERRANDA VENTILATORE SPL30	SHUTTER ROD SPL30	2,00
8	SER/AT/SPL25		SERRANDA VENTILATORE SPL25	FAN SHUTTER SPL25	7,00
	SER/AT/SPL35		SERRANDA VENTILATORE SPL30 - SPL35S	FAN SHUTTER SPL30-SPL35S	7,00
11	PRESS		PRESSOSTATO VENTILATORE SPL25-30-35S-50-65-100	SPL FAN PRESSURE SWITCH SPL25-30-35S-50-65-100	52,00
12	FOT		FOTORESISTENZA VENTILATORE SPL25-30	FAN PHOTORESISTANCE SPL 25-30	36,00
	FOT7		FOTORESISTENZA VENTILATORE SPL35S-50-65-100	FAN PHOTORESISTANCE SPL 35S-50-65-100	39,00
14	MOT/SPL25		MOTORE VENTILATORE SPL25	FAN ENGINE SPL25	112,00
	MOT/SPL35		MOTORE VENTILATORE SPL30	FAN ENGINE SPL30	112,00
	MOT/SPL35S		MOTORE VENTILATORE SPL35S	FAN ENGINE SPL35S	112,00
	MOT/SPL50		MOTORE VENTILATORE SPL50	FAN ENGINE SPL50	144,00
	MOT/SPL65		MOTORE VENTILATORE SPL65	FAN ENGINE SPL65	144,00
	MOT/SPL100		MOTORE VENTILATORE SPL100	FAN ENGINE SPL100	204,00
15	CO5NMCF		CONNETTORE 5 POLI NERO	BLACK 5 POLAR CONNECTOR	7,00
16	CO3NMCF		CONNETTORE 3 POLI NERO	BLACK 3 POLAR CONNECTOR	5,00
17	CO7N3V4MCF		CONNETTORE 7 POLI 3 NERO -4 VERDE	3 BLACK-4GREEN 7 POLAR CONNECTOR	9,00
18	CO7N4V3MCF		CONNETTORE 7 POLI 3 MARRONE -4 NERO	3 BROWN -4 BLACK 7 POLAR CONNECTOR	9,00
19	RPAS		RACCORDO PASSACAPO	PASS CABLE CONNECTION	7,00
20	GPAS		GUARNIZIONE PASSACAPO	PASS CABLE CONNECTION	4,00

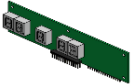
**QUADRO ELETTRONICO INTEGRATO MODELLO INTEGRATO AL BRUCIATORE
 INTEGRATED CONTROL PANEL QB MODEL FOR BURNERS
 SPL 25 - 30 - 35S - 50 - 65 - 100**

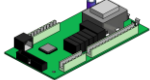

I pezzi di ricambio indicati alla pagina successiva sono quelli consigliati per la dotazione del servizio di manutenzione e riparazione, i prezzi di altri componenti vengono forniti su richiesta
 -----Spare parts in the next page are suggested for maintenance and technical service, the price of other components are supplied on demand

RICAMBI QUADRO ELETTRONICO INTEGRATO PER BRUCIATORI SPARE PARTS ELECTRONIC CONTROL PANEL INTEGRATED FOR BURNERS SPL 25 - 30 - 35S - 50 - 65 - 100

Posizione nel disegno	CODICE	IMMAGINE	DESCRIZIONE - I -	DESCRIZIONE - EN -	Prezzo €
2	QA04-25350		TASTIERA A MEMBRANA	MEMBRANE KEYBOARD	58,00
3	QA03-25350		INTERRUTTORE ON-OFF	ON OFF SWITCHER	14,00
5	QA08-25350		DISPLAY	DISPLAY	82,00
9	QB09-25065		CONNETTORE SPINA 5 POLI NERO - MCF	BLACK 5 POLAR PLUG CONNECTOR - MCF	7,00
10	QB10-25065		CONNETTORE SPINA 3 POLI NERO - MCF	BLACK 3 POLAR PLUG CONNECTOR - MCF	5,00
11	QA09-25350		SCHEDA PLC	PLC CARD	356,00
14	QA12-25350		RELE' C/SOZ MY2 SICUREZZA	RELE' C/SOZ MY2 SAFETY	26,00
17	QA10-25350		RELE' CRYDOM COMANDO COCLEA	RELE' CRYDOM FEED SCREW CONTROL	34,00
19	QA11-25350		REGOLATORE VELOCITA' MOTORE	ENGINE SPEED REGULATOR	156,00
24	QB24-25065		CONNETTORE PRESA 3 POLI BIANCO -FCF	WHITE 3 POLAR PIN CONNECTOR - FCF	5,00
25	QB25-25065		CONNETTORE PRESA 7 POLI 3 NERO 4 MARR.-FCF	7 POLAR PIN CONNECTOR 3 BLACK 4 BROWN -FCF	9,00

**QUADRO ELETTRONICO MODELLO PER APPLICAZIONE A BORDO CALDAIA
ELECTRONIC CONTROL PANEL MODELON BOILER FOR BURNERS
SPL 25 - 30 - 35S - 50 - 65 - 100**

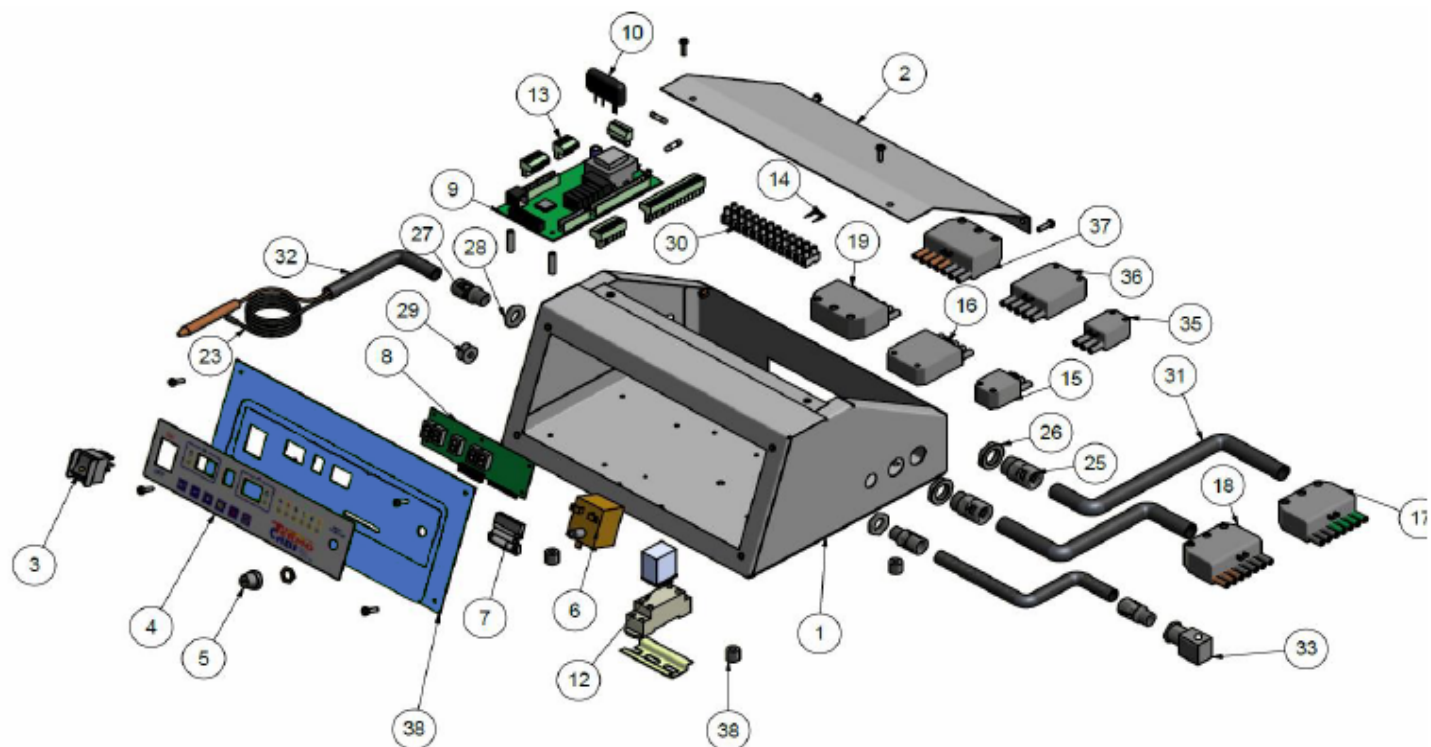

I pezzi di ricambio indicati alla pagina successiva sono quelli consigliati per la dotazione del servizio di manutenzione e riparazione, i prezzi di altri componenti vengono forniti su richiesta

-----Spare parts in the next page are suggested for maintenance and technical service, the price of other components are supplied on demand.

		RICAMBI QUADRO ELETTRONICO QC PER BRUCIATORI--- SPARE PARTS FOR CONTROL PANEL QC FOR BURNERS SPL 25 - 30 - 35S - 50 - 65 - 100			
Posizione nel disegno	CODICE	IMMAGINE	DESCRIZIONE - I -	DESCRIZIONE - EN -	Prezzo €
3	QA03-25350		INTERRUTTORE ON-OFF SPL25-30-35S-50-65-100	ON-OFF SWITCHER SPL25-30-35S-50-65-100	14,00
4	QA04-25350		TASTIERA A MEMBRANA SPL25-30-35S-50-65-100	MEMBRANE KEYBOARD SPL25-30-35S-50-65-100	58,00
6	QC06-25350		TERMOSTATO DI SICUREZZA SPL25-30-35S-50-65-100	SAFETY THERMOSTAT SPL25-30-35S-50-65-100	42,00
8	QA08-25350		DISPLAY SPL25-30-35S-50-65-100	DISPLAY SPL25-30-35S-50-65-100	82,00
9	QA09-25350		SCHEDA PLC SPL25-30-35S-50-65-100	PLC CARD SPL25-30-35S-50-65-100	356,00
10	QA10-25350		RELE' CRYDOM COMANDO COCLEA SPL25-30-35S-50-65-100	RELE' CRYDOM FEED SCREW SPL25-30-35S-50-65-100	34,00
11	QA11-25350		REGOLATORE VELOCITA' MOTORE SPL25-30-35S-50-65-100	MOTOR SPEED REGULATOR SPL25-30-35S-50-65-100	156,00
12	QA12-25350		RELE' C/SOZ. MY2 SICUREZZA SPL25-30-35S-50-65-100	SAFETY RELE' C/SOZ.MY2 SPL25-30-35S-50-65-100	26,00
15	QA15-25350		CONNETTORE PRESA 3 POLI - FCF - SPL25-30-35S-50-65-100	3 POLAR PLUG CONNECTOR-FCF- SPL25-30-35S-50-65-100	5,00
16	QA16-25350		CONNETTORE PRESA 5 POLI - FCF - SPL25-30-50-65-100	5 POLAR PLUG CONNECTOR-FCF- SPL25-30-35S-50-65-100	7,00
17	QA17-25350		CONNETTORE PRESA 7 POLI 3 NERO - 4VERDE - FCM - SPL25-30-35S-50-65-100	7 POLARPLUG CONNECTOR 3BLACK- 4GREEN - FCM - SPL25-30- 35S-50-65-100	9,00
18	QA18-25350		CONNETTORE PRESA 7 POLI 3 MARR - 4NERO - FCM - SPL25-30-35S-50-65-100	7 POLAR PLUG CONENCTOR 3BROWN-4BROWN - FCM - SPL25-30-35S-50-65-100	9,00
19	QA19-25350		CONNETTORE PRESA 7 POLI 4MARR - 3NERO - FCF - SPL25-30-35S-50-65-100	7 POLAR PLUG CONENCTOR 3BROWN-4BROWN -FCM - SPL25-30-35S-50-65-100	9,00
23	TESO		TERMOSONDA L=2,2 SPL25-30-35S-50-65-100	THERMOPROBE L=2,2 SPL25-30-35S-50-65-100	18,00

QUADRO ELETTRONICO MODELLO QE PER BRUCIATORI SPL25-30-35S-50-65-100

Prodotti fino a Maggio 2009

ELECTRONIC CONTROL PANEL QE MODEL FOR BURNERS SPL25-30-35S-50-65-100

Distributed until May 2009

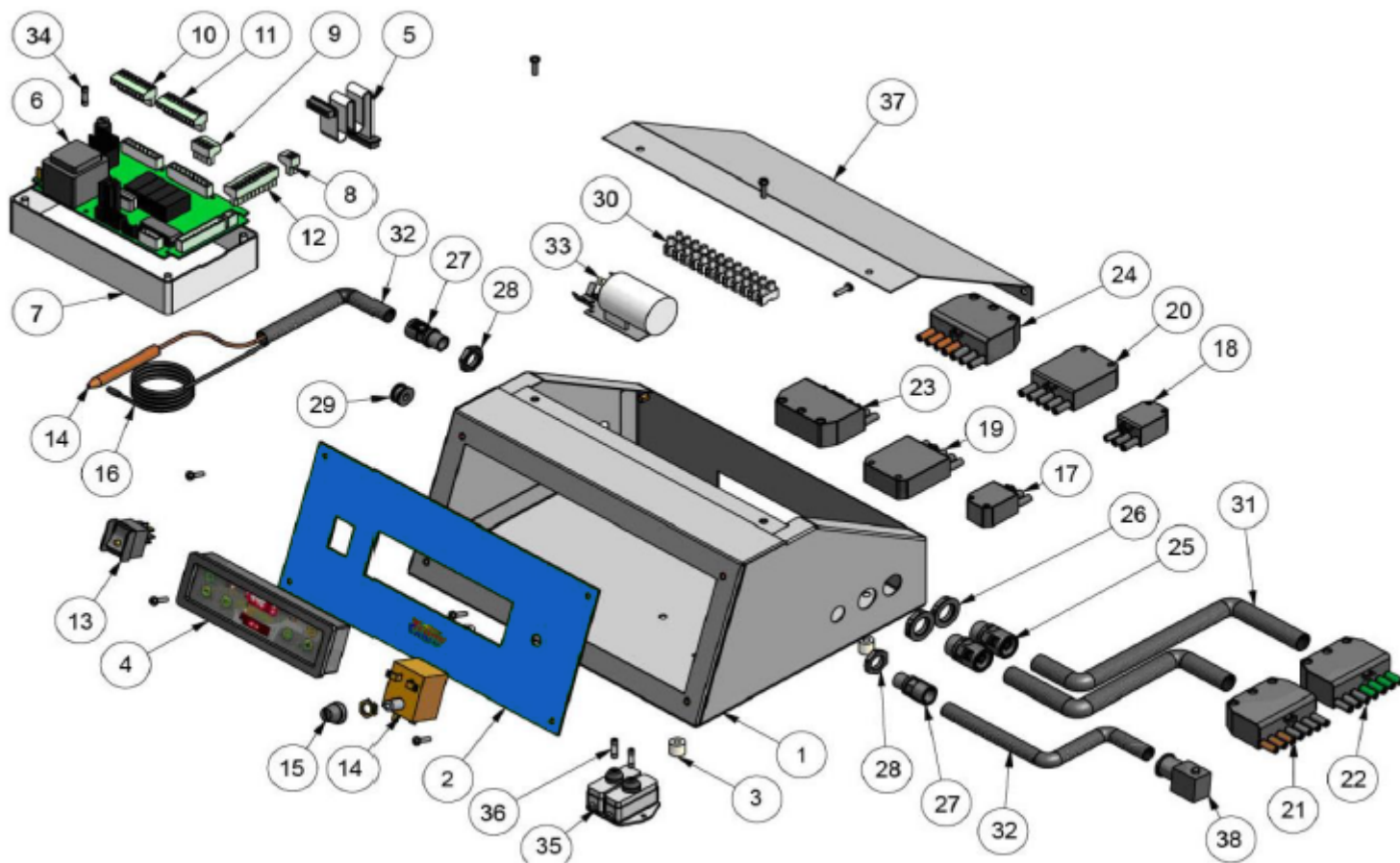

I pezzi di ricambio indicati alla pagina successiva sono quelli consigliati per la dotazione del servizio di manutenzione e riparazione, i prezzi di altri componenti vengono forniti su richiesta.
 Spare parts in the next page are suggested for maintenance and technical service, the price of other components are supplied on demand.



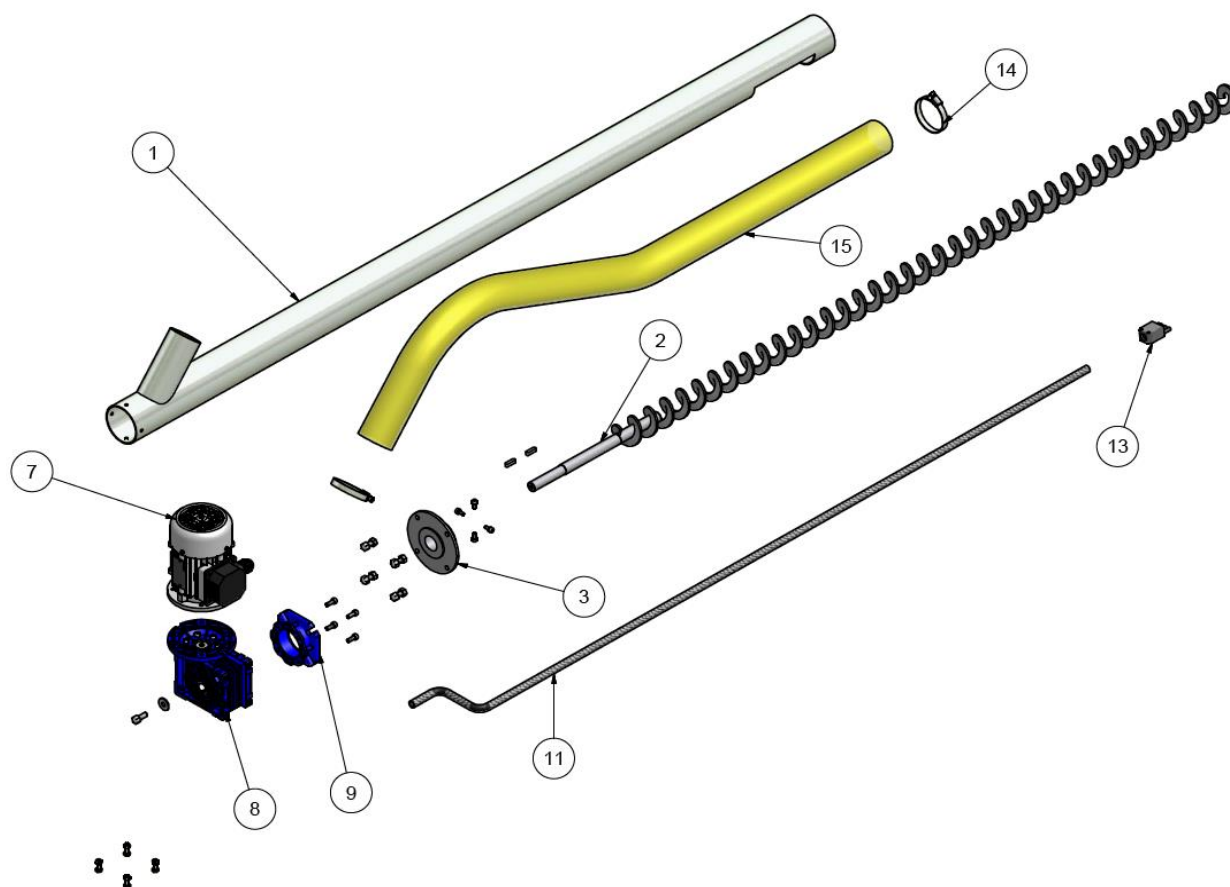

RICAMBI QUADRO ELETTRONICO BRUCIATORE - SPARE PARTS ELECTRONIC CONTROL PANEL BURNER SPL 25 - 30 - 35S - 50 - 65 - 100					
Posizione nel disegno	CODICE	IMMAGINE	DESCRIZIONE - I -	DESCRIZIONE - EN -	Prezzo €
4	DIOR		DISPLAY ORIZZONTALE SPL25-30-35S-50-65-100	HORIZONTAL DISPLAY SPL25-30-35S-50-65-100	95,00
6	SCHC		SCHEDA DI COMANDO BRUCIATORE SPL25-30-35S-50-65	BURNER CONTROLLER CARD SPL25-30-35S-50-65	188,00
	SCHC+T		SCHEDA DI COMANDO BRUCIATORE SPL100	BURNER CONTROLLER CARD SPL100	FUORI PRODUZIONE- OUT OF PRODUCTION
13	ONOF		INTERRUTTORE ON-OFF SPL25-30-35S-50-65-100	ON OFF SWITCHER SPL25-30-35S-50-65-100	14,00
14	TERS		TERMOSTATO DI SICUREZZA SPL25-30-35S-50-65-100	SECURITY THERMOSTAT SPL25-30-35S-50-65-100	42,00
15	COPR		COPRITERMOSTATO DI SICUREZZA SPL25-30-35S-50-65-100	COVER OF SECURITY THERMOSTAT SPL25-30-35S-50-65-100	IN DOTAZIONE AL THERMOSTATO EQUIPPED WITH THE THERMOSTAT
16	TESO		TERMOSONDE L = 2,2 mt SPL25-30-35S-50-65-100	PROBE L = 2,2 mt SPL25-30-35S-50-65-100	18,00
17	CO3PM		CONNETTORE PRESA 3 POLI SPL25-30-35S-50-65-100	3 POLAR CONNECTOR PLUG SPL25-30-35S-50-65-100	5,00
18	CO3PM		CONNETTORE SPINA 3 POLI SPL25-30-35S-50-65-100	3 POLAR CONNECTOR PIN SPL25-30-35S-50-65-100	5,00
19	CO5PM		CONNETTORE PRESA 5 POLI SPL25-30-35S-50-65-100	5 POLAR CONNECTOR PLUG SPL25-30-35S-50-65-100	7,00
20	CO5PM		CONNETTORE SPINA 5 POLI SPL25-30-35S-50-65-100	5 POLAR CONNECTOR PIN SPL25-30-35S-50-65-100	7,00
21	CO7PNV		CONN. PRESA 7 POLI NERO-VERDE SPL25-30-35S-50-65-100	7 POLAR CONN. PLUG BLACK-GREEN SPL25-30-35S-50-65-100	9,00
22	CO7PMN		CONN. PRESA 7 POLI MARRONE-NERO SPL25-30-35S-50-65-100	7 POLAR CONN. PLUG BLACK-GREEN SPL25-30-35S-50-65-100	9,00
23	CO7PMN		CONN. PRESA 7 POLI MARRONE-NERO SPL25-30-35S-50-65-100	7 POLAR CONN. PLUG BLACK-GREEN SPL25-30-35S-50-65-100	9,00
24	CO7PMN		CONN. SPINA 7 POLI MARRONE NERO SPL25-30-35S-50-65-100	7 POLAR CONN. PIN BLACK-GREEN SPL25-30-35S-50-65-100	9,00
33	LCRFI		FILTRO DI RETE SPL25-30-35S-50-65-100	SUPPRESSION FILTER SPL25-30-35S-50-65-100	24,00
34	FURE2 A		FUSIBILI PER RELE' SCHEDA SPL25	FUSE 4A SPL25-30-35S-50-65-100	Reperibili in commercio- found in the market
*****	La scheda SCHC+T fuori produzione è sostituita da equivalente prodotto -----Codice QA00-25350 QUADRO-SCHEDA PLC con applicazione sul quadro precedente da inviare in sede Termocabi per il rinnovo completo production is replaced by QA00-25350 CONTROL PANEL-PLC CARD, the old control panel has to be sent to Termocabi for complete renew				590,00

COCLEA D'ALIMENTAZIONE PELLET MODELLI 76/1740 E 89/1740
(per bruciatori prodotti da giugno 2009) SPL 25 - 30 - 35S - 50 - 65 -100
PELLET FEED SCREW MODELS 76/1740 AND 89/1740 (for burners distributed
starting from JUNE 2009) BURNERS SPL 25 - 30 - 35S - 50 - 65 -100

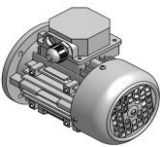

I pezzi di ricambio indicati alla pagina successiva sono quelli consigliati per la dotazione del servizio di manutenzione e riparazione, i prezzi di altri componenti vengono forniti su richiesta

-----Spare parts in the next page are suggested for maintenance and technical service, the price of other components are supplied on demand

		RICAMBI COCLEA MODELLO DA GIUGNO 2009 PER BRUCIATORI SPARE PARTS FEED SCREW JUNE 2009 FOR BURNERS			SPL 25 - 30 - 35S - 50 - 65 - 100
Posizione nel disegno	CODICE	IMMAGINE	DESCRIZIONE - I -	DESCRIZIONE - EN -	Prezzo €
2	CL02-761740		SPIRALE CON PERNO SPL25-30-35S-50	SCREW COIL WITH PIN SPL25-30-35S-50	178,00
	CL02-891740		SPIRALE CON PERNO SPL65-100	SCREW COIL WITH PIN SPL65-100	216,00
7	CL07-2550		MOTORE COCLEA SPL25-30-35S-50	SCREW ENGINE SPL25-35S-50	204,00
	CL07-65100		MOTORE COCLEA SPL65-100	SCREW ENGINE SPL65-100	306,00
8	CL08-2550		RIDUTTORE COCLEA SPL25-30-35S-50-65-100	SCREW REDUCER SPL25-30-35S-50-65-100	162,00
	CL08-65100		RIDUTTORE COCLEA SPL65-100	SCREW REDUCER SPL65-100	286,00
13	CL13-25100		CONNETTORE 3 POLI COCLEA SPL25- 30-35S-50-65-100	3 POLAR CONNECTOR FOR FEED SCREW SPL25-30-35S-50-65-100	5,00
15	EOLO		TUBO EOLO SPL25-30-35S-50-65-100 Prezzo al Mt.	EOLO PIPE SPL25-30-35S-50-65-100 Price per meter	44,00

COCLEA D'ALIMENTAZIONE PELLET MODELLI 76/1740 E 89/1740



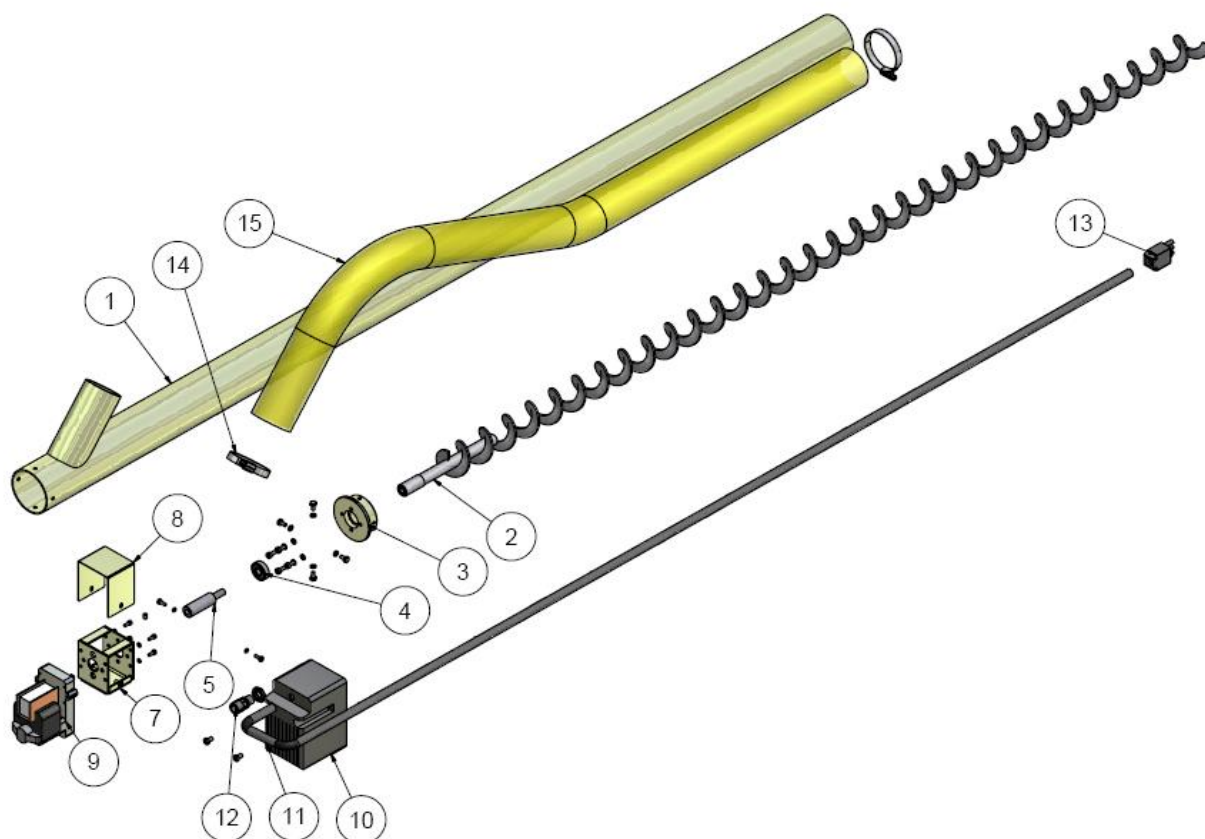



(in produzione fino a maggio 2009) PER BRUCIATORI SPL 25 - 30 - 35S - 50 - 65 - 100 PELLET FEED SCREW MODELS
SPL 76/1740 AND 89/1740 (distributed until May 2009) FOR BURNERS SPL 25 - 30 - 35S - 50 - 65 - 100

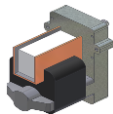

I pezzi di ricambio indicati alla pagina successiva sono quelli consigliati per la dotazione del servizio di manutenzione e riparazione, i prezzi di altri componenti vengono forniti su richiesta

-----Spare parts in the next page are suggested for maintenance and technical service, the price of other components are supplied on demand

**RICAMBI COCLEA MODELLO FINO A MAGGIO 2009 PER BRUCIATORI SPL 25 - 30 - 35S - 50 - 65 - 100 SPARE PARTS
FOR FEED SCREW MODEL MAY 2009 FOR BURNERS SPL 25 - 30 - 35S - 50 - 65 - 100**

Posizione nel disegno	CODICE	IMMAGINE	DESCRIZIONE - I -	DESCRIZIONE - EN -	Prezzo €
2	SPCL76		SPIRALE COCLEA CON PERNO SPL25-30-35S-50	SCREW COIL WITH PIN SPL25-30-35S-50	118,00
	SPCL89		SPIRALE COCLEA CON PERNO SPL65-100	SCREW COIL WITH PIN SPL65-100	206,00
4	CUCL		CUSCINETTO SPL25-30-35S-50-65-100	CUCL SPL25-30-35S-50-65-100	26,00
5	GTRD		GIUNTO MOTORIDUTTORE SPL25-30-35S-50-65-100	ROLL PIN SPL25-30-35S-50-65-100	40,00
9	MRD5		MOTORIDUTTORE SPL25-30-35S-50	SCREW ENGINE SPL25-30-35S-50	160,00
	MRD8		MOTORIDUTTORE SPL65-100	SCREW ENGINE SPL65-100	176,00
10	CMRD		CALOTTA MOTORIDUTTORE SPL25-30-35S-50-65-100	COVER SCREW ENGINE SPL25-30-35S-50-65-100	11,00
13	COP3PF		CONNETTORE 3 POLI SPL25-30-35S-50-65-100	3 POLAR CONNECTOR FOR FEED SCREW SPL25-30-35S-50-65-100	5,00
15	EOLO		TUBO EOLO SPL25-30-35S-50-65-100 Prezzo al Mt.	EOLO PIPE SPL25-30-35S-50-65-100 Price per meter	44,00